

### 8.3 RETURNS

The Customer Service Department will issue a Return Authorization (RA) number for all returns. The following information will be required:

1. Billing and a ship-to address.
2. Model and serial number.
3. Contact name and phone number.
4. Reason for return.
5. Purchase order (where applicable).
6. RA number on outside of the carton.

All material must be returned freight prepaid. All merchandise must be properly packaged and free of any corrosive, toxic or otherwise hazardous chemical. All items returned must reference Return Authorization.

### 8.4 CREDITS

No equipment will be accepted beyond six months after date of shipment from the factory. Only unused and undamaged equipment will be accepted for return to stock. All credits are based on acceptance of materials as new and unused by our inspection personnel. A restocking fee will apply. All equipment returned for credit must have a RA number and be returned freight prepaid.

# Electronic Metering Pumps

Series C, C PLUS, A PLUS, E, E-DC and E PLUS

## Installation Operation Maintenance Instruction

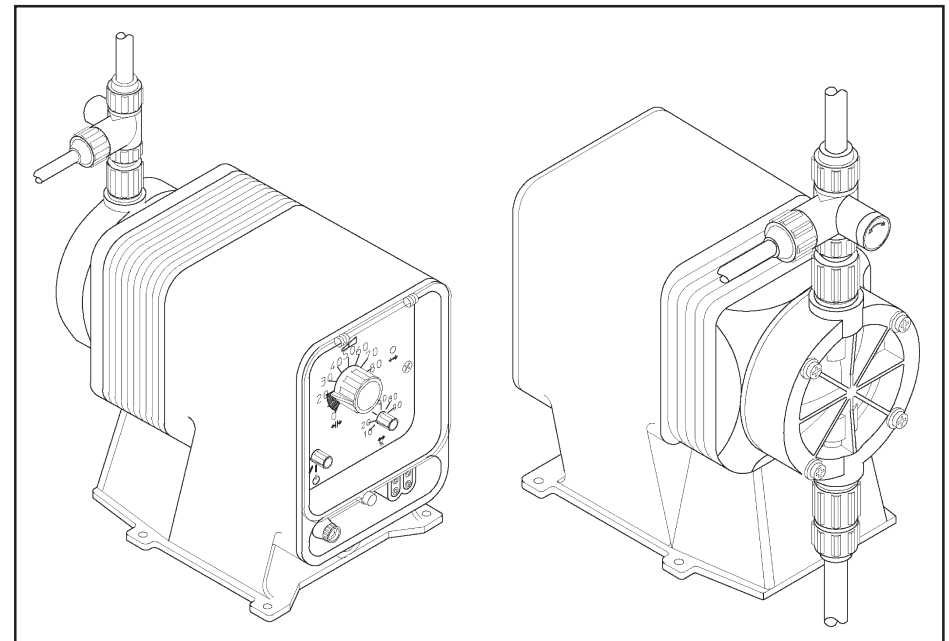

**READ ALL WARNINGS CAREFULLY  
BEFORE INSTALLING**

|  | <u>Page</u> |
|--|-------------|
| 1.0 SAFETY INSTRUCTIONS .....                        | 3           |
| 1.1 General Safety Considerations .....              | 3           |
| 1.2 Safety Operating Procedures .....                | 3           |
| 2.0 UNPACKING THE PUMP .....                         | 6           |
| 3.0 INTRODUCTION .....                               | 6           |
| 3.1 Principle of Operation .....                     | 6           |
| 3.2 Materials of Construction .....                  | 6           |
| 4.0 INSTALLATION .....                               | 7           |
| 4.1 Mounting .....                                   | 7           |
| 4.2 Piping .....                                     | 9           |
| 4.3 Wiring .....                                     | 10          |
| 4.4 Well Pump System Installation .....              | 10          |
| 5.0 STARTUP AND OPERATION .....                      | 11          |
| 5.1 Power .....                                      | 11          |
| 5.2 Priming .....                                    | 11          |
| 5.3 Capacity Control .....                           | 13          |
| 5.3.1 Stroke Frequency Adjustment .....              | 13          |
| 5.3.2 Stroke Length Adjustment .....                 | 13          |
| 5.3.3 Controlling Procedure .....                    | 13          |
| 5.4 Control Panel Symbols .....                      | 14          |
| 5.5 Operation By External Input Signals .....        | 15          |
| 5.5.1 Stop Functions .....                           | 15          |
| 5.5.2 External Pacing Function .....                 | 15          |
| 5.5.3 4-20mA DC Input Function .....                 | 16          |
| 6.0 MAINTENANCE .....                                | 17          |
| 6.1 Routine Maintenance .....                        | 17          |
| 6.2 Disassembly and Assembly Diaphragm Removal ..... | 18          |
| 6.3 Diaphragm Replacement .....                      | 18          |
| 6.4 Valve Replacement .....                          | 19          |
| 7.0 TROUBLESHOOTING .....                            | 20          |
| 8.0 POLICIES AND PROCEDURES .....                    | 23          |
| 8.1 Manufacturer's Product Warranty .....            | 23          |
| 8.2 European Technical File Location .....           | 23          |
| 8.3 Returns .....                                    | 24          |
| 8.4 Credits .....                                    | 24          |

**8.1 MANUFACTURERS PRODUCT WARRANTY**

The manufacturer warrants its equipment of its manufacture to be free of defects in material or workmanship. Liability under this policy extends for eighteen (18) months from the date of purchase or one (1) year from date of installation or whichever comes first. The manufacturer's liability is limited to repair or replacement of any device or part, which is returned, prepaid, to the factory and which is proven defective upon examination. This warranty does not include installation or repair cost and in no event shall the manufacturer's liability exceed its selling price of such part.

The manufacturer disclaims all liability for damage to its products through improper installation, maintenance, use or attempts to operate such products beyond their functional capacity, intentionally or otherwise, or any unauthorized repair. Replaceable elastomeric parts are expendable and are not covered by any warranty either expressed or implied. The manufacturer is not responsible for consequential or other damages, injuries or expense incurred through use of its products.

The above warranty is in lieu of any other warranty, either expressed or implied. The manufacturer makes no warranty of fitness or merchantability. No agent of ours is authorized to make any warranty other than the above.

For warranty and service matters within the European Union, contact the seller first or:

Fagotpad 2  
3822 CN Amersfoort  
The Netherlands

**8.2 EUROPEAN TECHNICAL FILE LOCATION**

P.O. Box 91  
Washington  
NE371YH  
United Kingdom

7.0 TROUBLESHOOTING cont'd.

| PROBLEM                    | PROBABLE CAUSE   | REMEDY   |
|----------------------------|--|--|
| <b>PUMP LOSES PRIME</b>    | 1. Dirty check valve.                                      | 1. Remove and replace or clean off any scale or sediment.  |
|                            | 2. Ball checks not seating or not sealing properly.        | 2. Check seat and ball checks for chips, clean gently. If deformity or deterioration is noted, replace part with proper material. Resulting crystals can hold check valves open, therefore, the valves must be disassembled and cleaned.   |
|                            | 3. Solution container allowed to run dry.                  | 3. Refill the tank with solution and prime. See 5.0 (Start-Up and Operation Section).  |
|                            | 4. Chemical Outgassing.                                    | 4. Bleed gas, use flooded suction and maintain chemical at room temperature (approx. 20°F) to minimize outgassing.   |
| <b>PUMP WILL NOT PRIME</b> | 1. Too much pressure at discharge.                         | 1. Turn off all pressure valves, relieve system pressure then loosen outlet tubing connection at discharge point. Remove discharge valve cartridge. Dampen ball check and valve seats with a few drops of solution. Set pump dial to maximum rate. When pump is primed, reconnect all tubing connectors. |
|                            | 2. Check valves not sealing.                               | 2. Disassemble, clean & check for deterioration, damage or swelling. Reassemble and wet the valve assembly, then prime. See 5.0 (Start-Up & Operating Section).  |
|                            | 3. Output dials not set at maximum.                        | 3. Always prime pump with output dial set at maximum rated capacity.   |
|                            | 4. Suction lift height too much. Maximum 5 ft (1.5 m)      | 4. Decrease suction lift or pull vacuum on pump discharge until pump is primed.  |
|                            | 5. Pump equipped with spring loaded high viscosity valves. | 5. Loosen discharge valve to aid in priming, take necessary safety precautions for spills, or apply vacuum to pump discharge.  |

1.0 SAFETY INSTRUCTIONS



When using chemical feed pumps, basic safety precautions should always be followed to reduce risk of fire, electric shock, and personal injury. Failure to follow these instructions could result in death or serious injury.



READ ALL INSTRUCTIONS

1.1 GENERAL SAFETY CONSIDERATIONS

- Always wear protective clothing including gloves and safety goggles when working on or near chemical metering pumps.
- Inspect tubing regularly when replenishing chemical solution for cracking or deterioration and replace as necessary. **(Always wear protective clothing and safety glasses when inspecting tubing.)**
- When pump is exposed to direct sunlight use U.V. resistant tubing.
- Follow directions and warnings provided with the chemicals from the chemical manufacturer. User is responsible for determining chemical compatibility with chemical feed pump.
- Secure chemicals and metering pumps, making them inaccessible to children and pets.
- Make sure the voltage on the chemical metering pump matches the voltage at the installation site.
- Do not cut plug or the ground lug off of the electrical cord – consult a licensed electrician for proper installation.
- Pump is **NOT** to be used to handle flammable liquids.

1.2 SAFETY OPERATING PROCEDURES

Each Electronic Metering Pump has been tested to meet prescribed specifications and safety standards.

Proper care in handling, installation and operation will help in ensuring a trouble free installation.

Please read all these cautionary notes prior to installation and start-up of your metering pump.

**Important:** Pump must be installed and used with supplied back pressure/injection valve. Failure to do so could result in excessive pump output.

- Handle the pump with care. Dropping or heavy impact causes not only external damage to the pump, but also to electrical parts inside.
- Install the pump in a place where the ambient temperature does not exceed 104°F (40°C). The pump is water resistant and dust proof by construction and can be use outdoors, however **do not operate the pump submerged**. To avoid high internal pump temperatures, do not operate in direct sunlight.

**CAUTION** Solenoid housing, head and pump housing may be hot to touch 160°F(70°C).

- Install the pump in a place convenient for its future maintenance and inspection, and then secure it to prevent vibration.
- Protective caps must be removed prior to installing tubing onto valve assemblies. Use tubing of specified size. Connect the tubing to the suction side securely to prevent the entrance of outside air. Make sure that there is no liquid leakage on the discharge side.
- Be careful to check that the voltage of the installation matches voltage indicated on the pump data label. Most pump models are equipped with a three-prong plug. Always be sure the pump is grounded. To disconnect, do not pull wire but grip the plug with fingers and pull out. Do not use the receptacle in common with heavy electrical equipment, which generates surge voltage. It can cause failure of the electronic circuit inside the pump.
- Tampering with electrical devices can be potentially hazardous. Always place chemicals and pump installation well out of the reach of children.
- Never repair or move the metering pump while operating. Always disconnect electrical power. **For safety, always wear protective clothing (protective gloves and safety glasses) when working on or near chemical metering pumps.**
- An air bleed valve is available for most models with tubing connections. Air purges should be performed when the pump-chamber contains no fluid at the time of start-up. As a safety measure, connect the return tubing to the air bleed valve and bypass fluid back to storage tank or a suitable drain.
- For accurate volume output, the pump must be calibrated under typical operating conditions.

7.0 TROUBLESHOOTING cont'd.

| PROBLEM                              | PROBABLE CAUSE  | REMEDY   |
|--------------------------------------|---|--|
| <b>LOSS OF CHEMICAL RESIDUAL</b>     | <ol style="list-style-type: none"> <li>1. Pump setting too low.</li> <li>2. Scale at injection point.</li> <li>3. Solution container allowed to run dry</li> </ol>                    | <ol style="list-style-type: none"> <li>1. Adjust to higher setting (pump must be operating to adjust stroke length knob).<br/><br/>Clean injection parts with 8% muriatic acid or undiluted vinegar. (Also, see Maintenance Section).</li> <li>2. Refill the tank with solution and prime. (See Start-up and Operation Section).</li> </ol>  |
| <b>TOO MUCH CHEMICAL</b>             | <ol style="list-style-type: none"> <li>1. Pump setting too high.</li> <li>2. Chemical in solution tank too rich.</li> <li>3. Siphoning of chemical into well or main line.</li> </ol> | <ol style="list-style-type: none"> <li>1. Lower pump setting (pump must be operating to adjust stroke length knob).</li> <li>2. Dilute chemical solution. NOTE: For chemical that reacts with water, it may be necessary to purchase a more dilute grade of chemical direct from chemical supplier.</li> <li>3. Test for suction or vacuum at the injection point. If suction exists, install an anti-siphon valve.</li> </ol> |
| <b>LEAKAGE AT TUBING CONNECTIONS</b> | <ol style="list-style-type: none"> <li>1. Worn tube ends.</li> <li>2. Chemical attack.</li> </ol>   | <ol style="list-style-type: none"> <li>1. Cut off end of tubing (about 1 in/2.5 cm) and then reconnect as before.</li> <li>2. Consult your seller for alternate material.</li> </ol>   |
| <b>LEAKAGE AT FITTING</b>            | <ol style="list-style-type: none"> <li>1. Loose fittings.</li> <li>2. Broken or twisted gasket.</li> <li>3. Chemical attack.</li> </ol>   | <ol style="list-style-type: none"> <li>1. Tighten hand tight. Replace gasket if hand tightening does not stop leakage.</li> <li>2. Check gaskets and replace if broken or damaged.</li> <li>3. Consult your pump supplier for alternate material.</li> </ol>   |

## 7.0 TROUBLESHOOTING

| PROBLEM                | PROBABLE CAUSE                               | REMEDY  |
|------------------------|--|---|
| <b>FAILURE TO PUMP</b> | 1. Leak in suction side of pump.             | 1. Examine suction tubing. If worn at the end, cut approximately one inch (2.5 cm) off and reconnect.   |
|                        | 2. Valve seats not sealing.                  | 2. Clean valve seats if dirty or replace with alternate material if deterioration is noted.   |
|                        | 3. Low setting on pump.                      | 3. When pumping against pressure, the dial should be set above 20% capacity for a reliable feed rate.   |
|                        | 4. Low suction level.                        | 4. Solution must be above foot valve strainer.  |
|                        | 5. Diaphragm ruptured.                       | 5. Replace diaphragm as shown in 6.0 "Maintenance Section". Check for pressure above rated maximum at the injection point. NOTE: Chemical incompatibility with diaphragm material can cause diaphragm rupture and leakage around the pump head. |
|                        | 6. Pump head cracked or broken.              | 6. Replace pump head as shown in 6.0 "Maintenance Section". Make sure fittings are hand tight only. Using pliers and wrench can crack pump head. Also, chemical incompatibility can cause cracking and subsequent leakage.                      |
|                        | 7. Pump head contains air or chlorine gas.   | 7. Bleed pump head, see 5.0 "Start-up and Operation".   |
|                        | 8. Breakdown or disconnection of wiring.     | 8. Connect wiring properly. Check fuse or circuit breaker.  |
|                        | 9. Voltage drop.                             | 9. Take measures after investigation of cause.  |
|                        | 10. Malfunction of electronic control board. | 10. Contact supplier.   |

- Chemicals used may be dangerous and should be used carefully and according to warnings on the label. Follow the directions given with each type of chemical. Do not assume chemicals are the same because they look alike. Always store chemicals in a safe location away from children and others. We cannot be responsible for the misuse of chemicals being fed by the pump. Always have the material safety data sheet (MSDS) available for any fluid being pumped.
- All pumps are pretested with water before shipment. Remove head and dry thoroughly if you are pumping a material that will react with water, (i.e. sulfuric acid, polymers). Valve seats, ball checks, gaskets, and diaphragm should also be dried. Before placing pump into service, extreme care should be taken to follow this procedure.
- Valve cartridges are stamped to indicate fluid flow direction. Always install so that markings read from top to bottom, with the arrow pointing in the direction of flow.
- When metering hazardous material **DO NOT** use plastic tubing, strictly use proper rigid pipe. Consult supplier for special adapters or valve assemblies.
- **Pump is NOT to be used to handle or meter flammable liquids or materials.**
- Standard white discharge tubing is not recommended for installations exposed to direct sunlight. Consult supplier for special black tubing.
- Factory will not be held responsible for improper installation of pump, or plumbing. All cautions are to be read thoroughly prior to hookup and plumbing. For all installations a professional plumber should be consulted. Always adhere to local plumbing codes and requirements.
- When using pump with pressurized systems, make sure the pressure of the system does not exceed the maximum pressure rating on the pump data label. Be sure to depressurize system prior to hook up or disconnecting a metering pump.
- Electronic power modules are equipped with automatic reset thermal overload devices and may reset unexpectedly.

## 2.0 UNPACKING THE PUMP

Check all equipment for completeness against the order and for any evidence of shipping damage. Shortages or damages should be reported immediately to the carrier and to the seller of the equipment.

The carton should contain:

- Metering Pump
- Clear Flexible Suction Tubing\*
- Stiff White Discharge Tubing\*
- Foot valve/Strainer Assembly
- Backpressure Injection Valve Assembly
- Manual
- Bleed Valve Assembly\*
- Strainer Weight\*

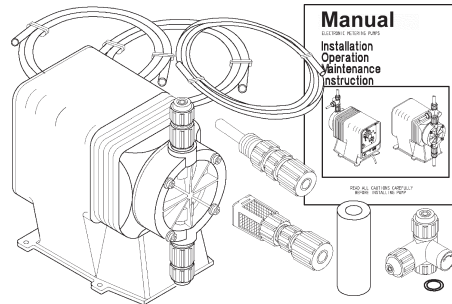

FIGURE 1

\*Items may or may not be included depending on model.

Make sure that all items have been removed from the shipping carton before it is discarded.

## 3.0 INTRODUCTION

These installation, operation and maintenance instructions cover your electronic metering pump. Refer to the pump data label to determine the actual model.

### 3.1 PRINCIPLE OF OPERATION

Diaphragm metering pumps are used to dispense chemicals or fluids. This is achieved by an electromagnetic drive mechanism (solenoid), which is connected to a diaphragm. When the solenoid is pulsed by the control circuit it displaces the diaphragm, which, through the use of check valves, moves the fluid out the discharge under pressure. When the solenoid is de-energized it returns the diaphragm and pulls more fluid into the pump head and the cycle repeats.

The pump stroke rate is controlled by an internal circuit and is changed by turning the rate knob. The mechanical stroke length is controlled by the stroke length knob. Some models do not allow stroke rate control and do not have the stroke rate knob.

### 3.2 MATERIALS OF CONSTRUCTION

The wetted materials (those parts that contact the solution being pumped) available for construction are FPP (glass filled polypropylene), PVC, SAN, Hypalon, Viton, PTFE or FTF, 316 Stainless Steel, PVDF, Ceramic and Alloy C. These materials are very resistant to most chemicals. However, there are some chemicals, such as strong acids or organic solvents, which cause deterioration of some elastomer and plastic parts, such as the diaphragm, valve seats, or head.

## 6.3 DIAPHRAGM REPLACEMENT cont'd.

- Apply grease to areas of the diaphragm that contact the deflection plate.
- Slide the diaphragm deflection plate onto the back of the diaphragm stud, radius side towards the diaphragm. Next slide two shims onto the diaphragm threaded stud and screw the diaphragm into the EPM unit. Refer to Figure 14. Turn diaphragm clockwise until deflection plate and shims are tight against solenoid shaft and the diaphragm stops turning. If there is a gap between the adaptor and diaphragm, repeat the procedure removing one shim each time until the diaphragm just touches the adaptor or is slightly recessed.
- If not already done, adjust stroke length to 50%. Place the pump head onto the adaptor with valve flow arrows pointing up and install and tighten pump head screws. Tighten screws until pump head pulls up against adaptor.

**NOTE: Adjust stroke length only when pump is running!**

- Adjust stroke length back to 100% for easier priming and place pump back into service.

## 6.4 VALVE REPLACEMENT

- Flush pump to clean any chemical from pump head.
- Unplug pump, release system pressure, and disconnect tubing or piping.
- Unscrew valve cartridges and discard. Also remove o-rings down inside the pump head.
- Install new valve cartridges with stamped letters reading from top to bottom, and the arrow pointing in the direction of flow. Hand tighten only, do not use wrenches or pliers. This is especially important when the pump head is made of SAN material.
- Reconnect tubing or piping and reinstall the pump.
- Check for leaks around newly installed fittings.

- If the pump has been out of service for a month or longer, clear the pump head valve assemblies by pumping fresh water for approximately 30 minutes. If the pump does not operate normally after this “purging run”, replace cartridge valve assemblies.

## 6.2 DISASSEMBLY AND ASSEMBLY DIAPHRAGM REMOVAL

Flush pump head and valve assemblies out by running pump with water or other suitable neutralizing solution. Wash outside of pump if chemical has dripped on pump. Set stroke length knob of pump to 0% and unplug pump.

Depressurize the system and disconnect tubing or piping from the pump. Remove the four pump head screws and then remove the pump head assembly.

Remove the diaphragm by grasping it at the outer edge and turning it counter clockwise until it unscrews from the electronic power module (EPM). Don't lose the deflector plate or diaphragm shims which are behind the diaphragm, they are needed for re-assembly. Note shim quantity may be from 0 to 2.

Inspect diaphragm, if it is intended to be used again look for indications of the PTFE face being overstretched, (localized white areas) or the elastomer on the back of the diaphragm being worn. Excessive amounts of either condition require diaphragm replacement.

## 6.3 DIAPHRAGM REPLACEMENT

- When replacing the diaphragm, it is always a good idea to replace the valve cartridges and other worn parts. A kit is available from your supplier with all parts necessary to completely rebuild your pump's wet end. All your supplier needs to know is the “KOPkit No.” on your pump's data label to supply this kit.
- Set pump stroke length at 50% and unplug the pump.
- If you kept the shims from the original diaphragm or know the original quantity you can avoid the next step for shimming the diaphragm.

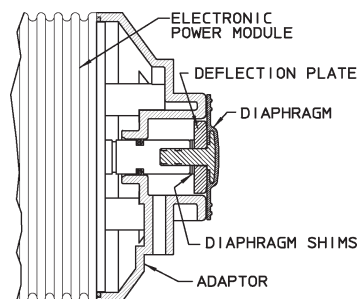

FIGURE 14

## 3.2 MATERIALS OF CONSTRUCTION cont'd.

Consult a Chemical Resistance Guide or Supplier for information on chemical compatibility.

Various manufacturers of plastics, elastomers and pumping equipment publish guidelines that aid in the selection of wetted materials for pumping commercially available chemicals and chemical compounds. Two factors must always be considered when using an elastomer or plastic part to pump chemicals. They are:

- The temperature of service: Higher temperatures increase the effect of chemicals on wetted materials. The increase varies with the material and the chemical being used. A material quite stable at room temperature might be affected at higher temperatures.
- Material choice: Materials with similar properties may differ greatly from one another in performance when exposed to certain chemicals.

## 4.0 INSTALLATION

The metering pump should be located in an area that allows convenient connections to both the chemical storage tank and the point of injection. The pump is water resistant and dust proof by construction and can be used outdoors, however, **do not operate submerged**. Avoid continuous temperatures in excess of 104°F (40°C). To do otherwise could result in damage to the pump.

### 4.1 MOUNTING

Typical mounting arrangements are shown in Figures 3, 4, and 5.

**Important:** Injection point must be higher than the top of the solution supply tank to prohibit gravity feeding, unless suitable backpressure is always present at the injection point. Installation of an antisiphon valve will prohibit gravity feeding.

- For wall or shelf mounting refer to Figure 3. Connect suction tubing to suction valve of chemical pump. Suction valve is the lower valve. Tubing should be long enough so that the foot valve/strainer assembly hangs about 1-2 inches (2-5 cm) above the bottom of chemical tank. To keep chemical from being contaminated, the tank should have a cover.

- Flooded suction mounting (installing the pump at the base of the chemical storage tank, Figure 4) is the most trouble free type of installation and is recommended for very low output requirements. Since the suction tubing is filled with chemical, priming is accomplished quickly and the chance of losing prime is reduced.

To mount pump, drill four holes of .25" (6 mm) diameter in the shelf as shown in the dimension drawing (Figure 2). Attach pump securely using four #10 (M5) bolts and nuts.

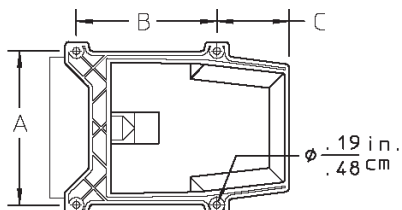

**MOUNTING HOLE DIMENSIONS**

| HOUSING SIZE | DIMENSIONS (in./cm.) |           |          |
|--------------|----------------------|-----------|----------|
|              | A                    | B         | C        |
| HSG.#1       | 4.50/11.4            | 3.00/7.6  | 1.75/4.4 |
| HSG.#2       | 4.81/12.2            | 4.38/11.1 | 2.19/5.6 |
| HSG.#3       | 5.56/14.1            | 4.38/11.1 | 2.19/5.6 |

FIGURE 2

- The pump can be mounted on top of a solution tank as shown in Figure 5. Install chemical pump on the cover. Insert suction tubing through the center hole and cut tubing so foot valve/strainer hangs about 1 or 2 inches (2-5 cm) above the bottom of the tank. Mount the chemical pump rigidly by drilling four .25" (6 mm) holes and using four #10 (M5) screws and nuts.

- USE AN ANTI-SIPHON VALVE IN THE DISCHARGE LINE whenever the fluid pressure in the discharge line is below atmospheric pressure. This can occur if the injection point is on the suction side of a water pump or against a "negative" head such as when feeding down into a well.

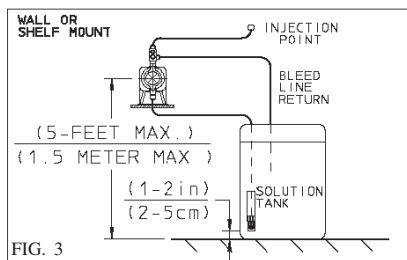

FIG. 3

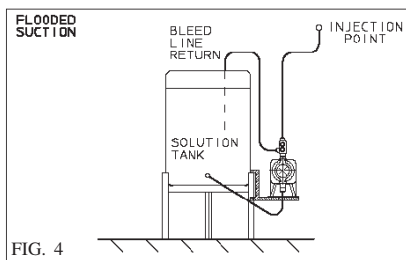

FIG. 4

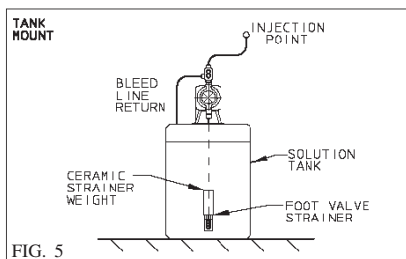

FIG. 5

5.5.3 4-20mA DC INPUT FUNCTION cont'd.

- The signal cord polarity is:  
Black = Common  
White = Positive  
Wrong polarity can result in excess flow.
- Signal input impedance is 124 ohms.
- Remove cap from pump socket labeled 4-20 mA, use polarized cord supplied with pump to connect control circuit to pump. Plug cord into pump socket labeled 4-20 mA.

6.0 MAINTENANCE



**Before performing any maintenance or repairs on chemical metering pumps, be sure to disconnect all electrical connections, insure that all pressure valves are shut off and pressure in the pump and lines has been bled off.**

**Always wear protective clothing, gloves and safety glasses when performing any maintenance or repairs on chemical metering pumps.**

6.1 ROUTINE MAINTENANCE

- Routinely check the physical operating condition of the pump. Look for the presence of any abnormal noise, excessive vibration, low flow and pressure output or high temperatures [when running constantly at maximum stroke rate, the pump housing temperature can be up to 160°F (70°C)].
- For optimum performance, cartridge valves should be changed every 6-12 months. Depending on the application, more frequent changes may be required. Actual operating experience is the best guide in this situation.
- Repeated short-term deterioration of valve seats and balls usually indicates a need to review the suitability of wetted materials selected for the application. Contact the supplier for guidance.
- Check for leaks around fitting or as a result of deteriorating tubing e.g. when standard white translucent discharge tubing is exposed to direct sunlight. Take appropriate action to correct leak by tightening fittings or replacing components.
- Keep the pump free of dirt and debris as this provides insulation and can lead to excessive pump temperatures.

- When the “ON” signal pulse is input, the pump operates one stroke and the fluid is discharged. In addition, the pump can be operated continuously at a rate of up to 125 strokes/min. by repeated input of “ON” and “OFF” signals.
- After receiving an input signal, the pump generates the necessary power pulse to actuate the solenoid. The external signal input is debounced by the pump circuit. The pump will not stroke in response to a spurious or erratic input signal that follows at a rate greater than 125 spm. If the external signal rate exceeds 125 spm, the pump will stroke at half the external signal rate to prevent overdosing and to protect the pump from overheating.
- The input signal must be in the form of closure of a mechanical relay, other mechanical switching device, or of a solid-state switching device. Voltage signals are prohibited. The switching resistance of either mechanical or solid-state devices must be 100 ohms or below when ON and 1 megohm or above when OFF. If any type of solid-state device is employed, it must be installed with proper polarity, if required for the device; and leakage current must not exceed 200 microamperes to prevent false triggering in the OFF state.
- Cycle rate of the input signal should not exceed 125 times per minute.
- Typical wiring is shown at right for use with switch closure flowmeters. (Figure 12)
- 10 millisecond contact time required for each “ON” input signal.

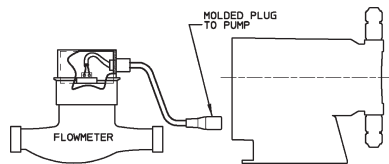

FIGURE 12

### 5.5.3 4-20mA DC INPUT FUNCTION (E Plus only)

The pump’s stroke rate can also be controlled by a 4-20 mA DC signal to the terminal marked [4-20 mA].

- For the 4-20 mA input to have any effect on the pump output rate, the AUTO/OFF/MANUAL switch must be in the AUTO position.
- The 4-20 mA input signal affects the pump’s outputs as per the graph below:

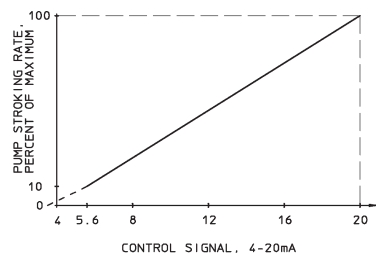

FIGURE 13

## 4.2 PIPING

- Use provided tubing of specified size for connection. Connect tubing securely to prevent leakage of chemical and the entrance of air. Since plastic nuts are used for fittings, they should not be tightened excessively (i.e. hand tighten only). NPT suction and discharge valves must **NOT** be over tightened. Hold fitting in place while adding piping and fittings. NPT suction and discharge valves should only be tightened 25 to 35 in. lbs. (4.5-6.3 kg/cm).
- If the air bleed valve assembly is being used, a return line (tubing) should be securely connected and routed back to the storage tank. **To avoid possible injury from chemicals do not attempt to prime using a bleed valve without installing a return line.**
- When pump is shelf mounted or top mounted on tank, suction tubing should be kept as short as possible.
- To maintain metering performance, a backpressure/injection valve is provided. The spring in the standard injection valve typically adds 17 - 20 PSI (1.17 - 1.38 BAR) to the line pressure, with the exception of the H8 pump, which adds 8 - 10 PSI (.55 - .69 BAR). The injection valve must be installed in the discharge line. Best practice is to install the injection valve at the point of chemical injection.
- If the discharge tubing is going to be exposed to direct sunlight, black tubing should be used instead of the standard white translucent tubing supplied with each pump. To obtain, contact supplier.
- To prevent clogging or check valve malfunction always install a strainer assembly to the end of the suction tubing (Figure 5). This foot valve/strainer assembly should always be installed 1 to 2 inches (2-5 cm) above the bottom of the chemical tank. This will help prevent clogging the strainer with any solids that may settle on the tank bottom. The chemical tank and foot valve/strainer should be cleaned regularly, to ensure continuous trouble free operation. If the chemical being pumped regularly precipitates out of solution or does not dissolve easily or completely (e.g. calcium hydroxide), a mixer should be used in the chemical tank. These are readily available in many motor configurations and mounting. To obtain, contact supplier.
- A flooded suction (tank liquid level always at a higher elevation than the pump) is recommended when pumping solutions such as sodium hypochlorite (NaOCl), hydrogen peroxide (H<sub>2</sub>O<sub>2</sub>), etc., which are likely to produce air bubbles. Maintaining a low liquid temperature will also help eliminate this problem.
- Pipe corrosion can result if dilution at the injection point does not occur rapidly. This problem is easily prevented by observing this simple rule: install injection fitting so that the end is in the center of the flow stream of the line being treated. Trim injector tip as required. See Figure 6. Note: Extended injection assemblies are available for large water lines. Consult your supplier for more information.

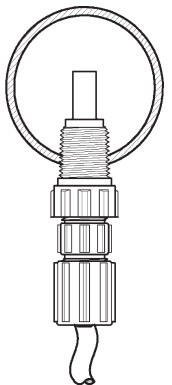



FIGURE 6

### 4.3 WIRING

-  **WARNING**—Risk of electrical shock. This pump is supplied with a three-prong grounding type power plug. To reduce risk of electric shock, connect only to a properly grounded, grounding type receptacle.
- The metering pump should be wired to an electrical source, which conforms to those on the pump data label. Applying higher voltage than the pump is rated for will damage the internal circuit.
- In the electronic circuit of the control unit, measures for surge voltage are made by means of surge absorbing elements and high voltage semiconductors. Nevertheless, excessive surge voltage may cause failure in some areas. Therefore, the receptacle should not be used in common with heavy electrical equipment, which generates high voltage. If this is unavoidable however, measures should be taken by (a) the installation of a surge-absorbing element (varistor of min. surge resistance 2000A) to the power supply connection of the pump, or (b) the installation of a noise suppression transformer.



- Signal input to the external pulse signal input terminals ([EXTERNAL], [STOP]) must be a no-voltage signal from relay-contacts etc. and the input of other signals is prohibited. (In the case of relay contacts, 100 ohms or below when ON and 1-meg ohms or above when OFF). The pulse duration of the input signal must be 10 milliseconds or over and the frequency of the input signal must not exceed 125 times per minute. Signal cord is provided with the pump.

### 4.4 WELL PUMP SYSTEM INSTALLATION

Ensure that the metering pump voltage matches the voltage of the well pump. Typical well pump electrical circuits are shown in Figure 8. All electric wiring should be installed in accordance to local codes by a licensed electrician.

Install the backpressure/injection (Figure 7) on the discharge side of the metering pump into a tee which is installed into the water line going to the pressure tank.

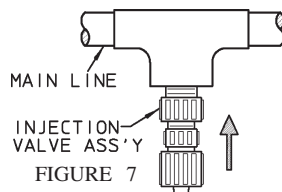

Pumps carrying the or "ETL Sanitation" (tested to NSF Standard-50) marks are listed for swimming pools, spas and hot tubs, and when proper materials are selected, are capable of handling but not limited to the following chemical solutions:

- |                            |                       |
|----------------------------|-----------------------|
| 12% ALUMINUM SULPHATE,     | 5% SODIUM CARBONATE,  |
| 2% CALCIUM HYPOCHLORITE,   | 10% SODIUM HYDROXIDE, |
| 12.5% SODIUM HYPOCHLORITE, | 10% HYDROCHLORIC ACID |

### 5.5 OPERATION BY EXTERNAL INPUT SIGNALS (Options):

The pump can be controlled by three types of input signals. All are fully isolated from AC input and from earth ground. The input socket connections are located at the bottom of the control panel face and the signal cords are provided with the pump. Remove rubber plugs to access plug sockets.

#### 5.5.1 STOP FUNCTION (E Plus, A Plus, C Plus & C only)

Operation of the pump can be stopped by an external signal input. When the external signal is input to the terminal marked ⊕ which is provided at the bottom of the control panel, the ⊕ lamp (red) lights up and operation of the pump is stopped. The stop function overrides both manual settings and external input.

 **CAUTION** Operation of more than one pump from the same contact closure will damage the pump circuits. When such operation is required, the pump circuits must be electrically isolated from one another by means of a multicontact control relay or similar means.

- The input signal must be in the form of closure of a mechanical relay or other mechanical switching device, or solid-state relay or other solid-state switching device. Voltage signals are prohibited. The switching resistance of either mechanical or solid-state devices must be 100 ohms or below when ON and 1 megohm or above when OFF. If any type of solid-state device is employed, it must be installed with the proper polarity, if required for the device; and leakage current must not exceed 200 microamperes to prevent false triggering in the OFF state.

The stop function is commonly used in conjunction with a tank float switch. The float switch contacts are normally open but when the tank level falls past a certain point the contacts close and the pump stops.

#### 5.5.2 EXTERNAL PACING FUNCTION (E Plus, A Plus, C Plus & C only)

The pump's stroke rate can be controlled by an external signal input. When the input signal line is connected and the EXTERNAL /OFF /MANUAL switch is in the external position and a contact signal is input to the terminal marked ⊕, the pump makes one discharge stroke.

 **CAUTION** Operation of more than one pump from the same contact closure will damage the pump circuits. When such operation is required, the pump circuits must be electrically isolated from one another by means of a multicontact control relay or similar means.



- Turn on the power to the pump. The green LED (not available on all models) will light up and flash off each time the pump strokes.
- Adjust the stroke rate knob to the 100% setting mark (for more information see Section 5.3, Capacity Control).
- Adjust the stroke length knob to the 100% setting mark if applicable (for more information see Section 5.3, Capacity Controls).
- If the discharge line is connected directly to a pressurized system it should be temporarily bypassed during priming of the pump. A bleed valve will simplify this operation by allowing easy bypass of the discharge fluid. Air must be purged from the pumphead before the pump will operate against pressure. (See Figure 9)

#### Air Bleed Operation:

- While pump is running, turn adjustment knob counterclockwise.
- Run with valve open until a solid stream of fluid comes out of the bypass tubing with no air bubbles.
- Close air bleed valve by turning adjustment screw clockwise.

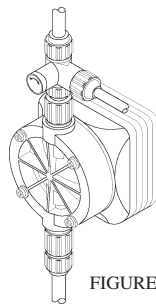

FIGURE 9

- Chemical should reach the pump head after a few minutes of operation. If not, remove the discharge fitting and moisten the discharge valve area (ball check and valve seats) with a few drops of **chemical being fed to the metering pump**. For safety, always use protective clothing and gloves, wear safety glasses and use a proper container to hold the chemical.
- If the pump continues not to prime, refer to Section 7.0, Troubleshooting, of these instructions.
- Once the pump has been primed and is pumping the chemical through the head, turn off the power, reconnect the discharge tubing (if it had been removed) and immediately clean any spilled chemical that is on the pump housing or head.
- Turn the power on once more and adjust the pump flow to the desired rate (see Section 5.3.3, Controlling Procedure).
- Always check the calibration of the pump after start-up. It's best to calibrate the pump under your typical use conditions.

## 5.3 CAPACITY CONTROL

Capacity can be controlled by means of the stroke length adjusting knob and/or stroke rate adjusting knob (except model C pumps). Control knobs provide coarse adjustment; use a calibration column for accurate calibration. Contact your pump supplier for proper calibration equipment.

### 5.3.1 Stroke Frequency Adjustment (E, E-DC, E Plus, A Plus & C Plus only)

- Stroke frequency can be controlled from 10 to 100% (12 to 125 strokes per minute) by means of the electronic circuit.
- Stroke frequency can be set by means of the stroke rate adjusting knob even while the pump is in operation. (See Figure 10)

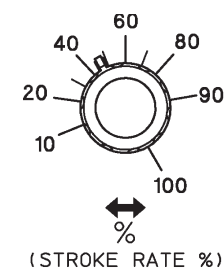

(STROKE RATE %)

### 5.3.2 Stroke Length Adjustment

- Stroke length can be controlled within 0 to 100% of the diaphragm displacement. It should be controlled within 20 to 100% for practical use.
- Stroke length can be set by means of the stroke length adjusting knob while the pump is in operation. **Do not turn the knob while the pump is stopped.**

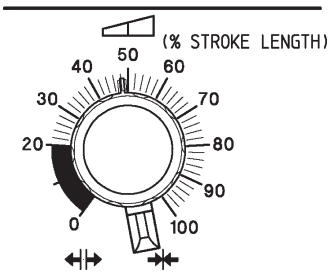

FIGURE 10

### 5.3.3 Controlling Procedure

Proper set points for stroke length and stroke frequency should be determined after consideration of the pump and characteristics of the fluid. The following procedure is recommended from the viewpoint of pump performance. **Note: The closer the stroke length is to 100%, the better the pump performance will be.**

- Set the stroke length to 100% then adjust the stroke frequency for coarse capacity control.
- Measure the capacity.
- When the measured capacity is less than the required value, increase the stroke frequency and measure the capacity again.
- Then, adjust the stroke length for fine capacity control.
- Finally, measure the capacity and make sure that the required value is obtained.